

TOP VIEW  
SCALE 1 : 30

ISOMETRIC VIEW  
SCALE 1 : 35

FRONT VIEW  
SCALE 1 : 30

SECTION B-B  
SCALE 1 : 30

SECTION A-A  
SCALE 1 : 30

SECTION A-A (ISOMETRIC)  
SCALE 1 : 35

SKYLIGHT CODES AND HOB SIZES					
SINGLE GLAZED	DOUBLE GLAZED	INTERNAL HOB SIZE A (mm)	INTERNAL HOB SIZE B (mm)	EXTERNAL HOB SIZE A (mm)	EXTERNAL HOB SIZE B (mm)
GXL100150AU-SG	GXL100150AU-DG	1000	1500	1180	1680
GXL100200AU-SG	GXL100200AU-DG	1000	2000	1180	2180
GXL100250AU-SG	GXL100250AU-DG	1000	2500	1180	2680
GXL100300AU-SG	GXL100300AU-DG	1000	3000	1180	3180
GXL100350AU-SG	GXL100350AU-DG	1000	3500	1180	3680
GXL100400AU-SG	GXL100400AU-DG	1000	4000	1180	4180
GXL100450AU-SG	GXL100450AU-DG	1000	4500	1180	4680
GXL100500AU-SG	GXL100500AU-DG	1000	5000	1180	5180
GXL150150AU-SG	GXL150150AU-DG	1500	1500	1680	1680
GXL150200AU-SG	GXL150200AU-DG	1500	2000	1680	2180
GXL150250AU-SG	GXL150250AU-DG	1500	2500	1680	2680
GXL150300AU-SG	GXL150300AU-DG	1500	3000	1680	3180
GXL150350AU-SG	GXL150350AU-DG	1500	3500	1680	3680
GXL150400AU-SG	GXL150400AU-DG	1500	4000	1680	4180
GXL150450AU-SG	GXL150450AU-DG	1500	4500	1680	4680
GXL150500AU-SG	GXL150500AU-DG	1500	5000	1680	5180
GXL200200AU-SG	GXL200200AU-DG	2000	2000	2180	2180
GXL200250AU-SG	GXL200250AU-DG	2000	2500	2180	2680
GXL200300AU-SG	GXL200300AU-DG	2000	3000	2180	3180
GXL200350AU-SG	GXL200350AU-DG	2000	3500	2180	3680
GXL200400AU-SG	GXL200400AU-DG	2000	4000	2180	4180
GXL200450AU-SG	GXL200450AU-DG	2000	4500	2180	4680
GXL200500AU-SG	GXL200500AU-DG	2000	5000	2180	5180
GXL250250AU-SG	GXL250250AU-DG	2500	2500	2680	2680
GXL250300AU-SG	GXL250300AU-DG	2500	3000	2680	3180
GXL250350AU-SG	GXL250350AU-DG	2500	3500	2680	3680
GXL250400AU-SG	GXL250400AU-DG	2500	4000	2680	4180
GXL250450AU-SG	GXL250450AU-DG	2500	4500	2680	4680
GXL250500AU-SG	GXL250500AU-DG	2500	5000	2680	5180

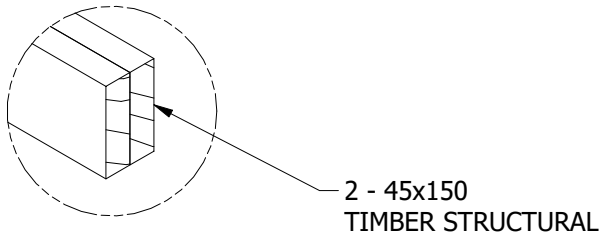
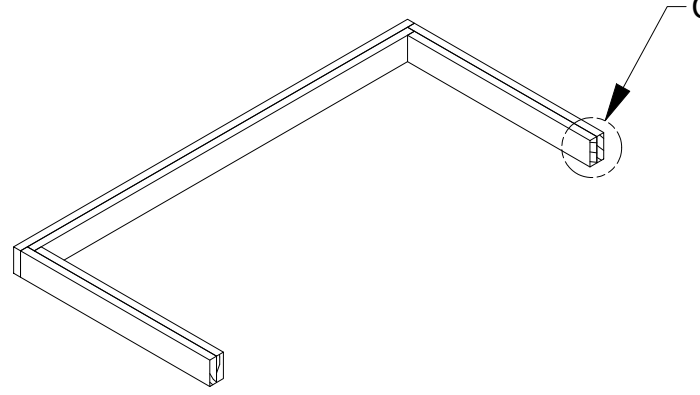
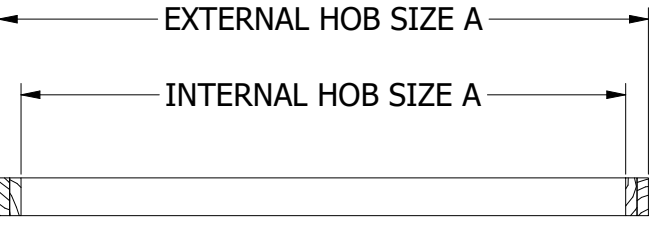
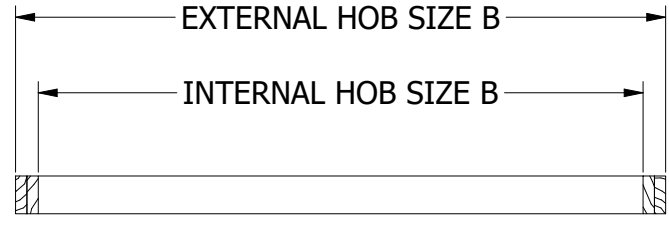

DETAIL C  
SCALE 1 : 10

CLIENT:	DESIGNER: J.BATOON	DATE CREATED: 12/07/2023	MATERIAL:	Skyspan Australia Pty Ltd 1 Gibbon Rd, Baulkham Hills NSW 2153, Australia Website: https://www.skyspan.com.au	
BUSINESS NAME:	DRAWN BY: M.AMIT	DATE DRAWN: 12/07/2023	THICKNESS (FOR SHEET):	REVISION	
PROJECT NAME:	MODIFIED BY:	DATE MODIFIED:	FINISH/COLOR:	SB-1991-00	
QUOTE NUMBER:	CHECKED BY:	CHECKED DATE:	ESTIMATED MASS: N/A	VOLUME: N/A	A
WORK ORDER NUMBER:	APPROVED BY:	APPROVED DATE:	SIZE A3	TITLE: GXL - 0° TIMBER HOB	
REFERENCE ORDER NUMBER:	TOLERANCES UNLESS OTHERWISE SPECIFIED IN MM			SCALE: DO NOT SCALE	FILENAME: SB-1991-00.iam
JOB NUMBER:	FLASHING #:	COPYRIGHT: THE DESIGN DETAILS SHOWN ON THIS DRAWING ARE SPECIFIC TO THIS PROJECT ONLY AND MAY NOT BE REPRODUCED IN WHOLE OR IN PART OR BE USED FOR ANY OTHER PROJECT OR PURPOSE WITHOUT THE WRITTEN CONSENT OF EVENT ENGINEERING PTY LTD. ©COPYRIGHT 2023 SKYSPAN			SHEET 1 OF 7
FLASHING QTY:					

6 5 4 3 2 1

D

D

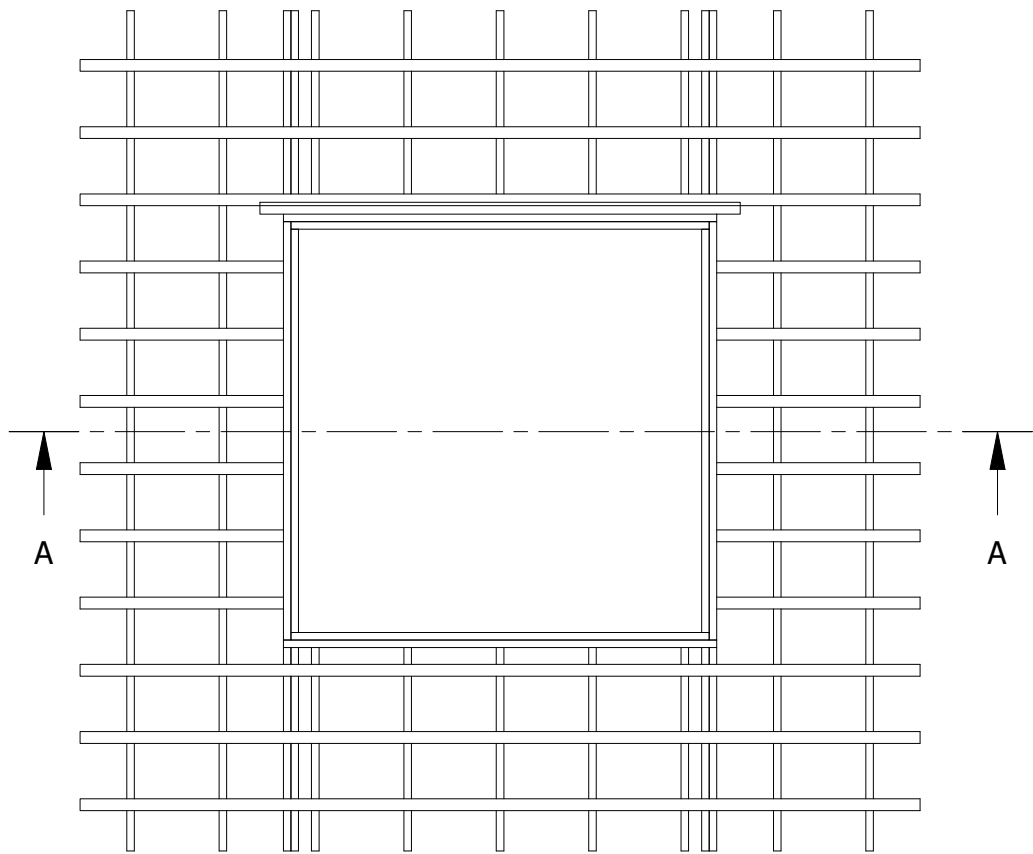

TOP VIEW  
SCALE 1 : 45

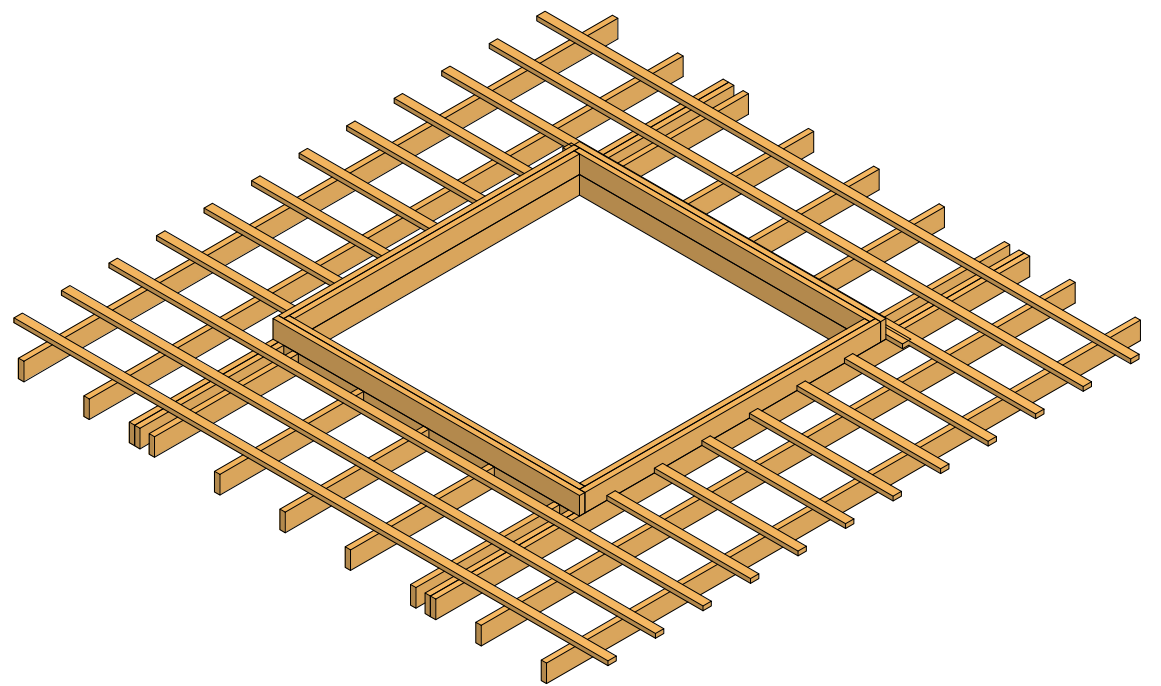

ISOMETRIC VIEW  
SCALE 1 : 45

C

C

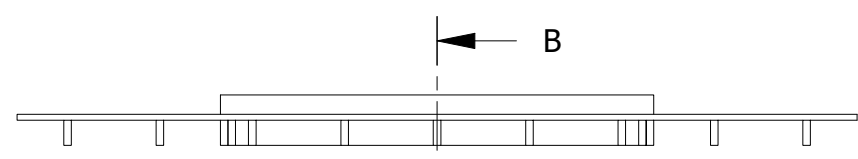

FRONT VIEW  
SCALE 1 : 45

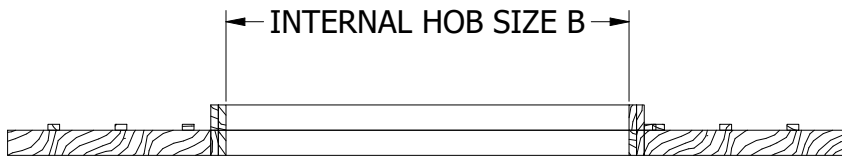

SECTION B-B  
SCALE 1 : 45

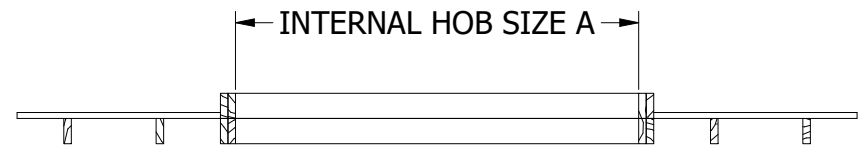

SECTION A-A  
SCALE 1 : 45

B

B

A

A

6 5 4 3 2 1

CLIENT:	DESIGNER: J.BATOON	DATE CREATED: 12/07/2023	MATERIAL:	<b>Skyspan Australia Pty Ltd</b> 1 Gibbon Rd, Baulkham Hills NSW 2153, Australia Website: <a href="https://www.skyspan.com.au">https://www.skyspan.com.au</a>	
BUSINESS NAME:	DRAWN BY: M.AMIT	DATE DRAWN: 12/07/2023	THICKNESS (FOR SHEET):		
PROJECT NAME:	MODIFIED BY:	DATE MODIFIED:	FINISH/COLOR:	PART NUMBER: SB-1991-00	REVISION A
QUOTE NUMBER:	CHECKED BY:	CHECKED DATE:	ESTIMATED MASS: N/A	VOLUME: N/A	<b>GXL - 0° TIMBER HOB</b>
WORK ORDER NUMBER:	APPROVED BY:	APPROVED DATE:	SIZE A3	SCALE: DO NOT SCALE	
REFERENCE ORDER NUMBER:	TOLERANCES UNLESS OTHERWISE SPECIFIED IN MM		THIRD ANGLE PROJECTION	FILENAME: SB-1991-00.iam	SHEET 2 OF 7
JOB NUMBER:	FLASHING #:	<small>COPYRIGHT: THE DESIGN DETAILS SHOWN ON THIS DRAWING ARE SPECIFIC TO THIS PROJECT ONLY AND MAY NOT BE REPRODUCED IN WHOLE OR IN PART OR BE USED FOR ANY OTHER PROJECT OR PURPOSE WITHOUT THE WRITTEN CONSENT OF EVENT ENGINEERING PTY LTD. ©COPYRIGHT 2023 SKYSPAN</small>			
	FLASHING QTY:				

6 5 4 3 2 1

D

D

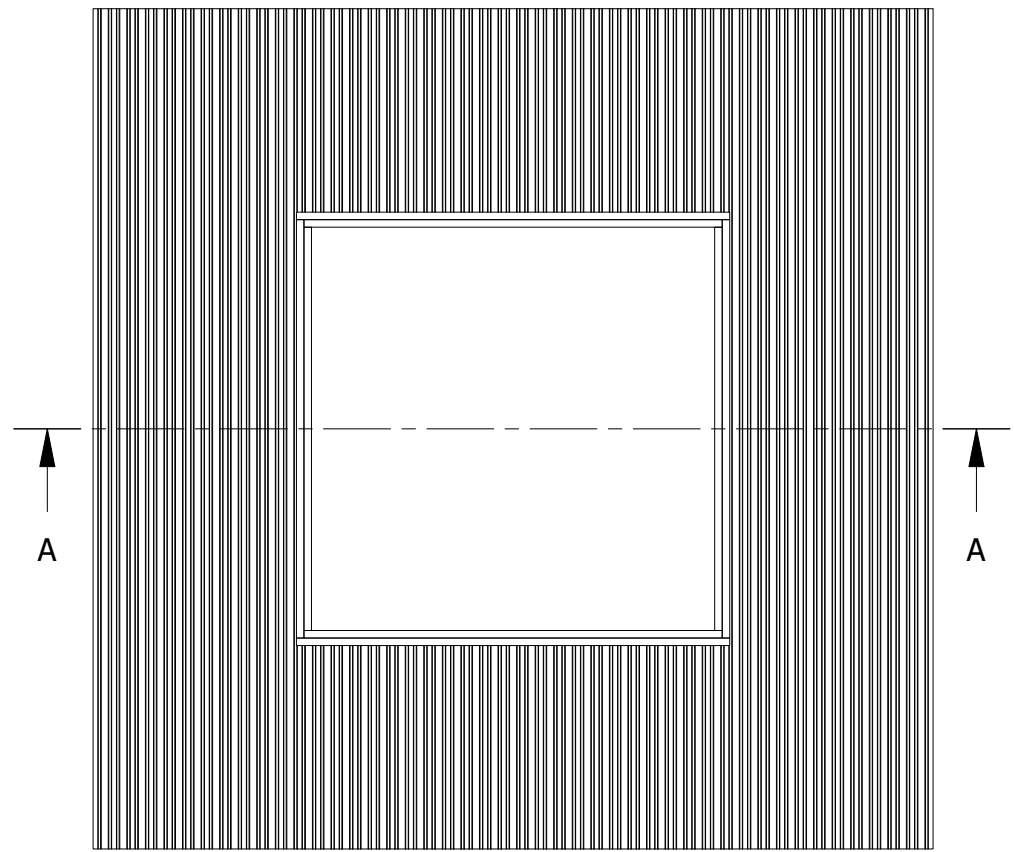

TOP VIEW  
SCALE 1 : 45

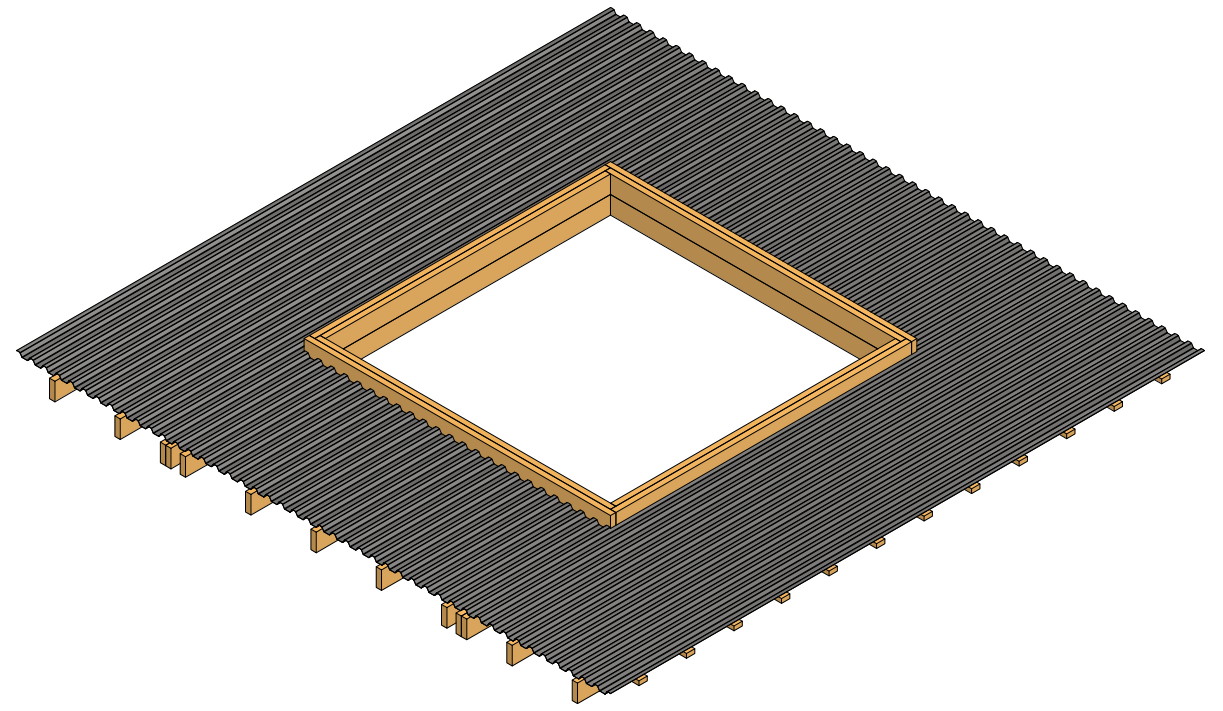

ISOMETRIC VIEW  
SCALE 1 : 45

C

C

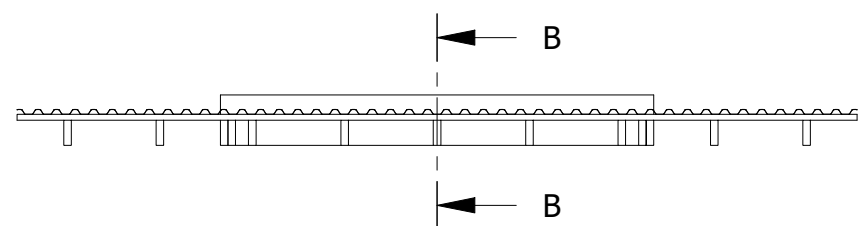

FRONT VIEW  
SCALE 1 : 45

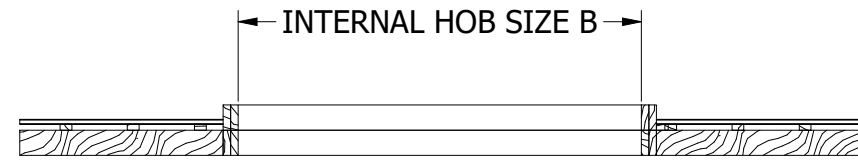

SECTION B-B  
SCALE 1 : 45

B

B

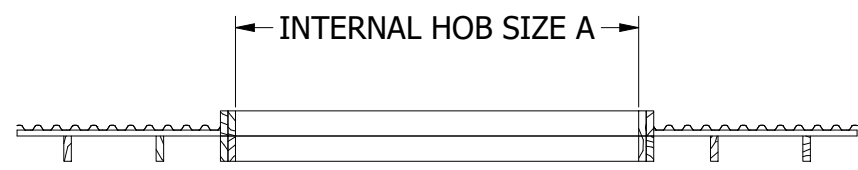

SECTION A-A  
SCALE 1 : 45

A

A

6 5 4 3 2 1

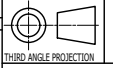
CLIENT:	DESIGNER: J.BATOON	DATE CREATED: 12/07/2023	MATERIAL:	Skyspan Australia Pty Ltd 1 Gibbon Rd, Baulkham Hills NSW 2153, Australia Website: <a href="https://www.skyspan.com.au">https://www.skyspan.com.au</a>		
BUSINESS NAME:	DRAWN BY: M.AMIT	DATE DRAWN: 12/07/2023	THICKNESS (FOR SHEET):	PART NUMBER: SB-1991-00		
PROJECT NAME:	MODIFIED BY:	DATE MODIFIED:	FINISH/COLOR:	ESTIMATED MASS: N/A		VOLUME: N/A
QUOTE NUMBER:	CHECKED BY:	CHECKED DATE:	ESTIMATED MASS: N/A	VOLUME: N/A		TITLE: GXL - 0° TIMBER HOB
WORK ORDER NUMBER:	APPROVED BY:	APPROVED DATE:	ESTIMATED MASS: N/A	VOLUME: N/A		FILENAME: SB-1991-00.iam
REFERENCE ORDER NUMBER:	TOLERANCES UNLESS OTHERWISE SPECIFIED IN MM			SIZE A3	SHEET 3 OF 7	
JOB NUMBER:	FLASHING #:	COPYRIGHT: THE DESIGN DETAILS SHOWN ON THIS DRAWING ARE SPECIFIC TO THIS PROJECT ONLY AND MAY NOT BE REPRODUCED IN WHOLE OR IN PART OR BE USED FOR ANY OTHER PROJECT OR PURPOSE WITHOUT THE WRITTEN CONSENT OF EVENT ENGINEERING PTY LTD. ©COPYRIGHT 2023 SKYSPAN		SCALE: DO NOT SCALE	SHEET 3 OF 7	
	FLASHING QTY:					

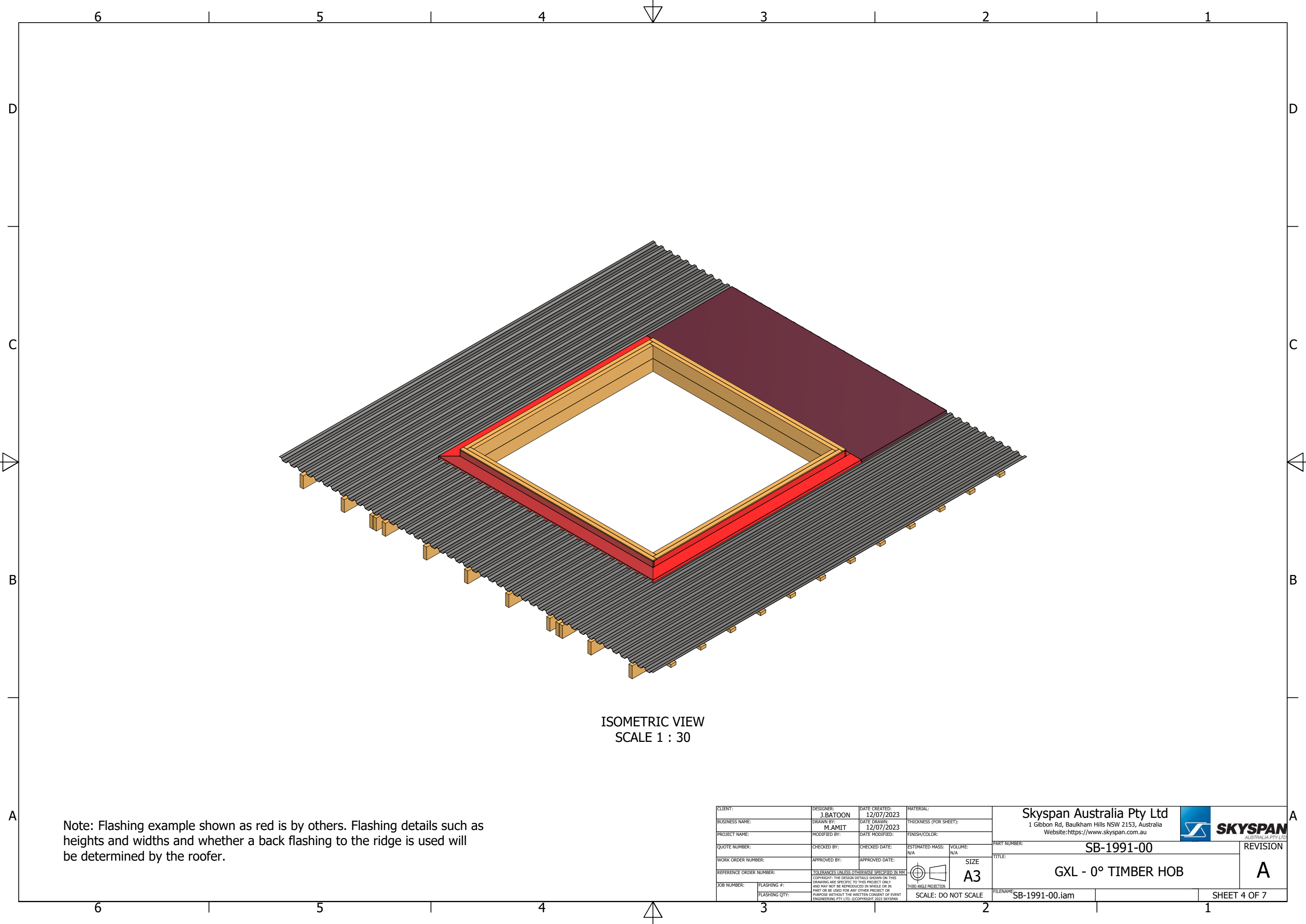

ISOMETRIC VIEW  
SCALE 1 : 30

Note: Flashing example shown as red is by others. Flashing details such as heights and widths and whether a back flashing to the ridge is used will be determined by the roofer.

CLIENT:	DESIGNER: J.BATOON	DATE CREATED: 12/07/2023	MATERIAL:	Skyspan Australia Pty Ltd 1 Gibbon Rd, Baulkham Hills NSW 2153, Australia Website: <a href="https://www.skyspan.com.au">https://www.skyspan.com.au</a>		
BUSINESS NAME:	DRAWN BY: M.AMIT	DATE DRAWN: 12/07/2023	THICKNESS (FOR SHEET):	PART NUMBER: SB-1991-00		
PROJECT NAME:	MODIFIED BY:	DATE MODIFIED:	FINISH/COLOR:	TITLE: GXL - 0° TIMBER HOB		A
QUOTE NUMBER:	CHECKED BY:	CHECKED DATE:	ESTIMATED MASS: N/A	VOLUME: N/A	SCALE: DO NOT SCALE	
WORK ORDER NUMBER:	APPROVED BY:	APPROVED DATE:			FILENAME: SB-1991-00.iam	SHEET 4 OF 7
REFERENCE ORDER NUMBER:	TOLERANCES UNLESS OTHERWISE SPECIFIED IN MM		SIZE A3			
JOB NUMBER:	FLASHING #:	<small>COPYRIGHT: THE DESIGN DETAILS SHOWN ON THIS DRAWING ARE SPECIFIC TO THIS PROJECT ONLY AND MAY NOT BE REPRODUCED IN WHOLE OR IN PART OR BE USED FOR ANY OTHER PROJECT OR PURPOSE WITHOUT THE WRITTEN CONSENT OF EVENT ENGINEERING PTY LTD. ©COPYRIGHT 2023 SKYSPAN</small>				
	FLASHING QTY:					

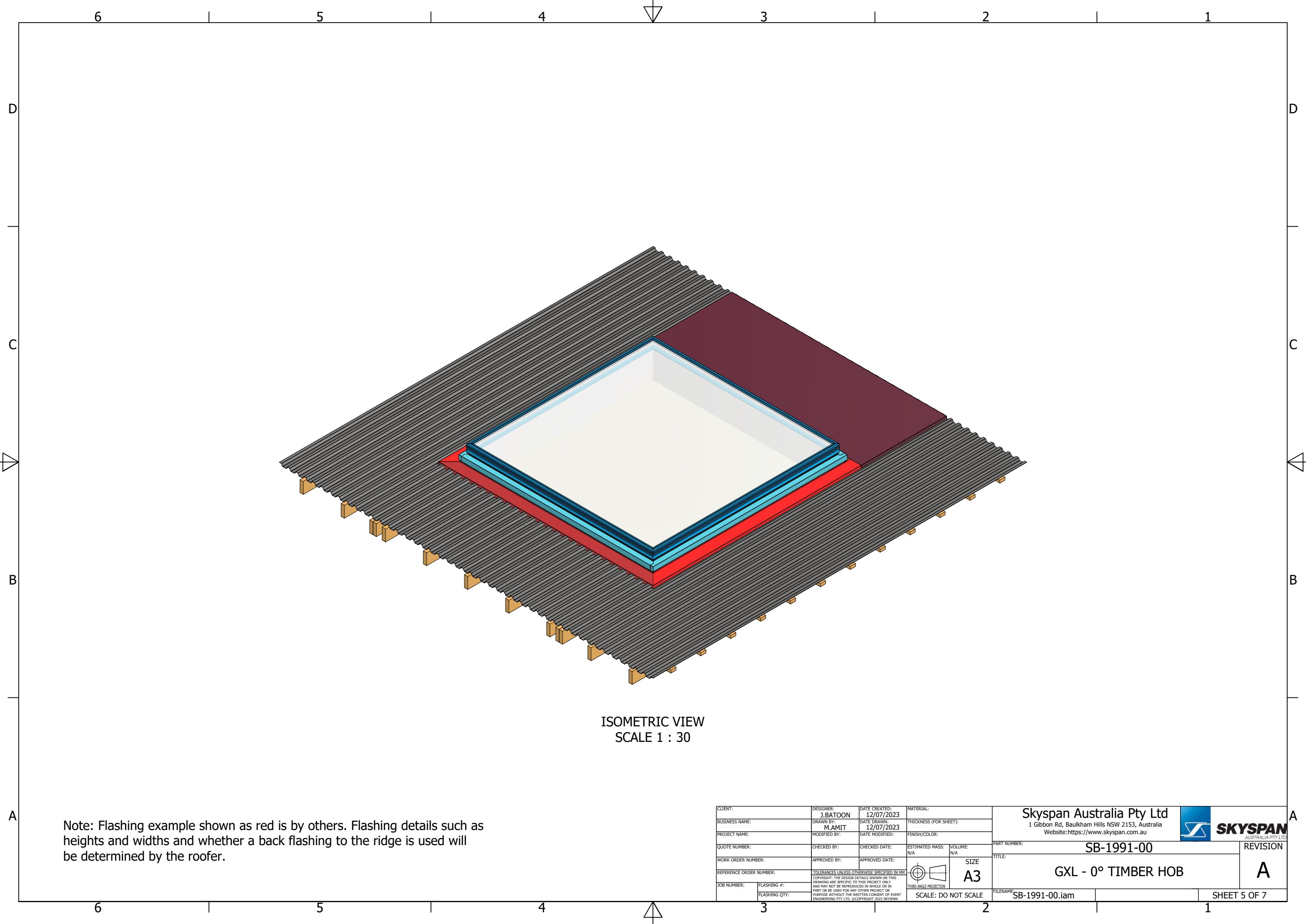

ISOMETRIC VIEW  
SCALE 1 : 30

Note: Flashing example shown as red is by others. Flashing details such as heights and widths and whether a back flashing to the ridge is used will be determined by the roofer.

CLIENT:	DESIGNER: J.BATOON	DATE CREATED: 12/07/2023	MATERIAL:	<b>Skyspan Australia Pty Ltd</b> 1 Gibbon Rd, Baulkham Hills NSW 2153, Australia Website: <a href="https://www.skyspan.com.au">https://www.skyspan.com.au</a>	
BUSINESS NAME:	DRAWN BY: M.AMIT	DATE DRAWN: 12/07/2023	THICKNESS (FOR SHEET):		
PROJECT NAME:	MODIFIED BY:	DATE MODIFIED:	FINISH/COLOR:	PART NUMBER: SB-1991-00	REVISION A
QUOTE NUMBER:	CHECKED BY:	CHECKED DATE:	ESTIMATED MASS: N/A	VOLUME: N/A	TITLE: GXL - 0° TIMBER HOB
WORK ORDER NUMBER:	APPROVED BY:	APPROVED DATE:	SIZE A3	SCALE: DO NOT SCALE	FILENAME: SB-1991-00.iam
REFERENCE ORDER NUMBER:	<small>TOLERANCES UNLESS OTHERWISE SPECIFIED IN MM</small> <small>COPYRIGHT: THE DESIGN DETAILS SHOWN ON THIS DRAWING ARE SPECIFIC TO THIS PROJECT ONLY AND MAY NOT BE REPRODUCED IN WHOLE OR IN PART OR BE USED FOR ANY OTHER PROJECT OR PURPOSE WITHOUT THE WRITTEN CONSENT OF EVENT ENGINEERING PTY LTD. ©COPYRIGHT 2023 SKYSPAN</small>			SCALE: DO NOT SCALE	SHEET 5 OF 7
JOB NUMBER:	FLASHING #:	FLASHING QTY:	THIRD ANGLE PROJECTION		

6 5 4 3 2 1

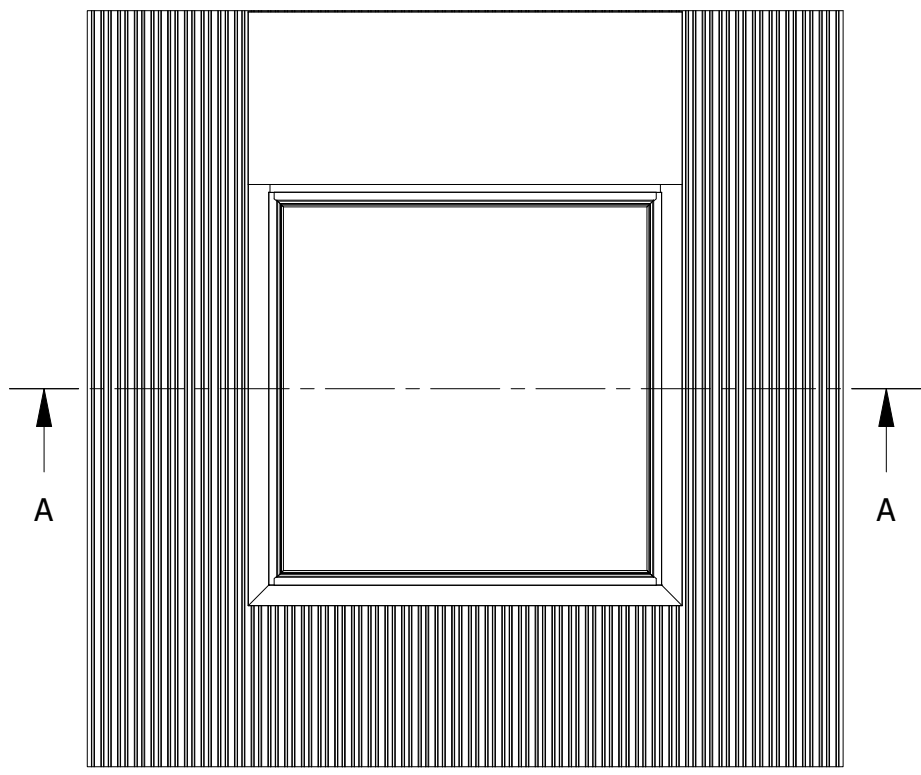

TOP VIEW  
SCALE 1 : 50

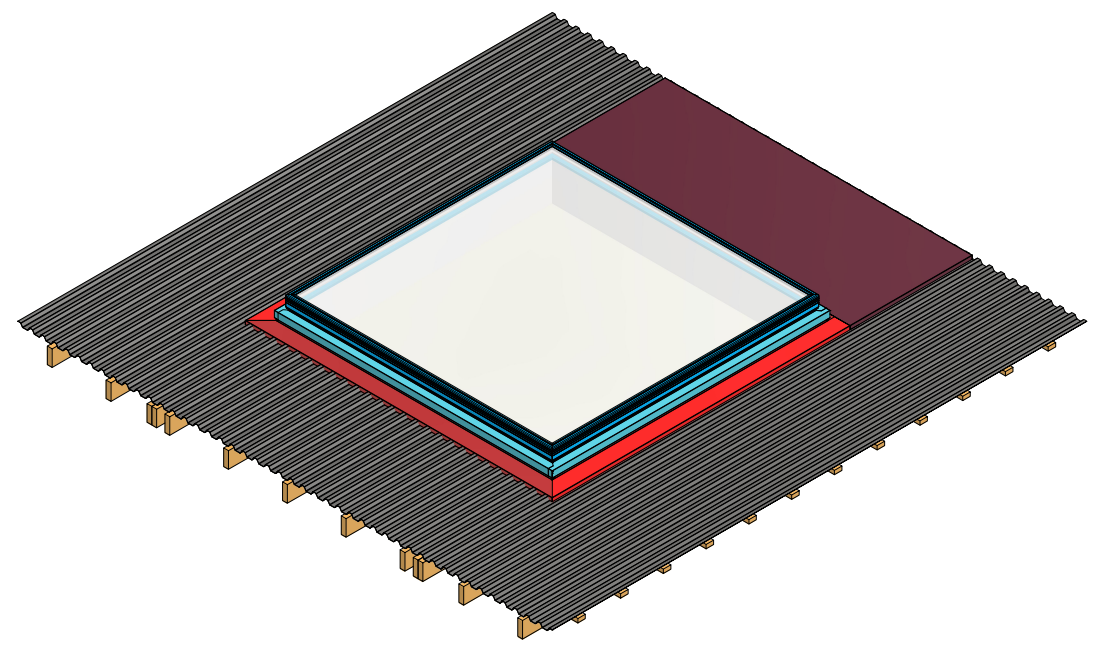

ISOMETRIC VIEW  
SCALE 1 : 50

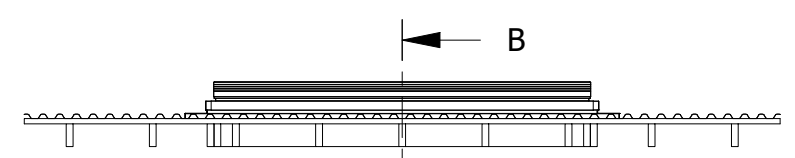

FRONT VIEW  
SCALE 1 : 50

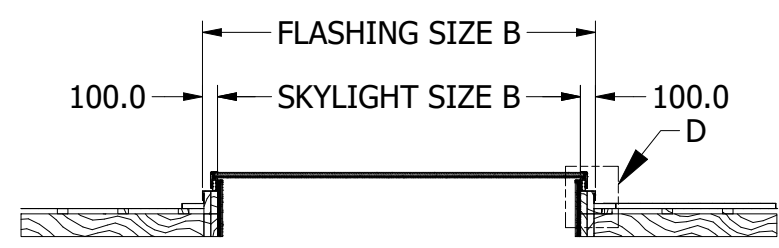

SECTION B-B  
SCALE 1 : 50

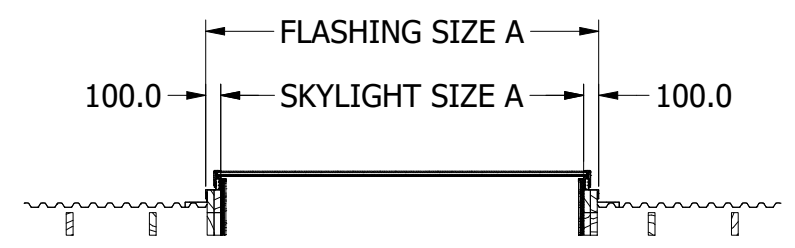

SECTION A-A  
SCALE 1 : 50

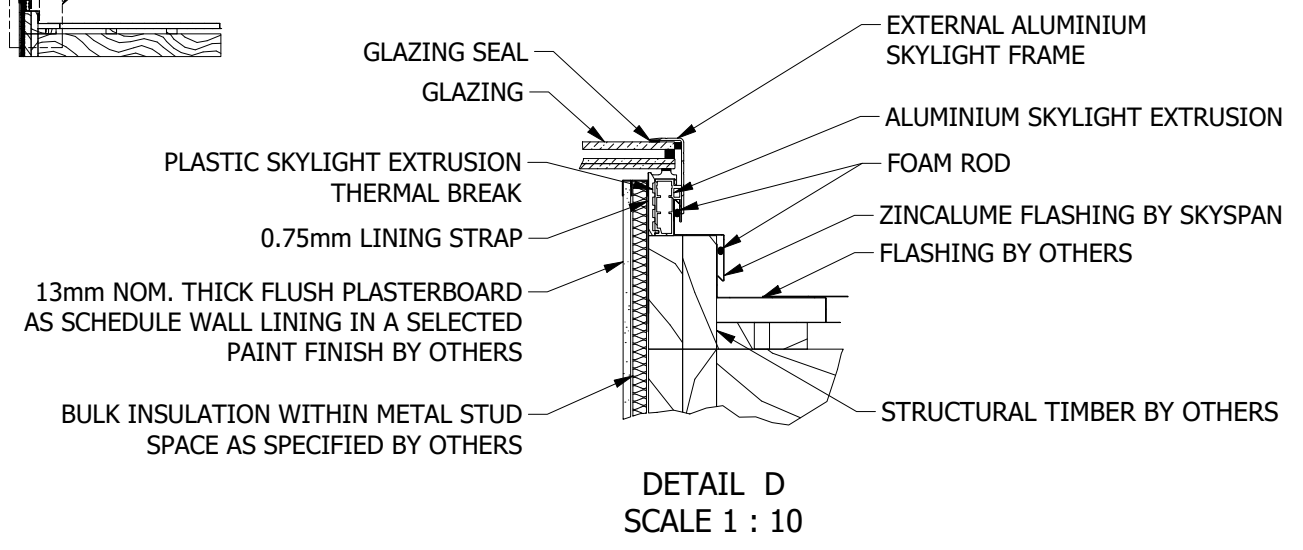

DETAIL D  
SCALE 1 : 10

CLIENT:	DESIGNER: J.BATOON	DATE CREATED: 12/07/2023	MATERIAL:	Skyspan Australia Pty Ltd 1 Gibbon Rd, Baulkham Hills NSW 2153, Australia Website: <a href="https://www.skyspan.com.au">https://www.skyspan.com.au</a>	
BUSINESS NAME:	DRAWN BY: M.AMIT	DATE DRAWN: 12/07/2023	THICKNESS (FOR SHEET):	PART NUMBER: SB-1991-00	
PROJECT NAME:	MODIFIED BY:	DATE MODIFIED:	FINISH/COLOR:	REVISION A	
QUOTE NUMBER:	CHECKED BY:	CHECKED DATE:	ESTIMATED MASS: N/A	TITLE: GXL - 0° TIMBER HOB	
WORK ORDER NUMBER:	APPROVED BY:	APPROVED DATE:	VOLUME: N/A	FILENAME: SB-1991-00.iam	
REFERENCE ORDER NUMBER:	TOLERANCES UNLESS OTHERWISE SPECIFIED IN MM			SHEET 6 OF 7	
JOB NUMBER:	FLASHING #:	COPYRIGHT: THE DESIGN DETAILS SHOWN ON THIS DRAWING ARE SPECIFIC TO THIS PROJECT ONLY AND MAY NOT BE REPRODUCED IN WHOLE OR IN PART OR BE USED FOR ANY OTHER PROJECT OR PURPOSE WITHOUT THE WRITTEN CONSENT OF EVENT ENGINEERING PTY LTD. ©COPYRIGHT 2023 SKYSPAN			SCALE: DO NOT SCALE
FLASHING QTY:	THIRD ANGLE PROJECTION			SIZE A3	

6 5 4 3 2 1

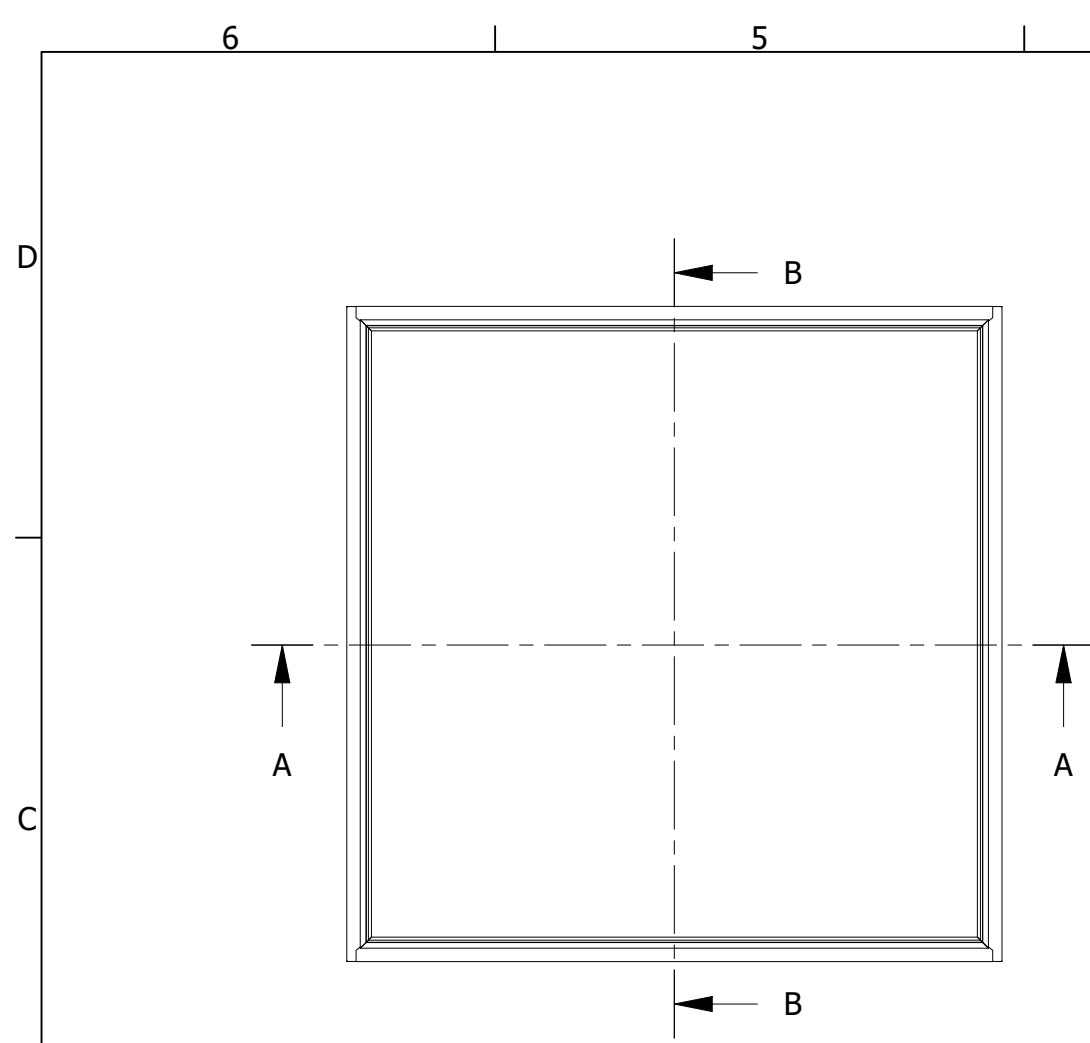

TOP VIEW  
SCALE 1 : 30

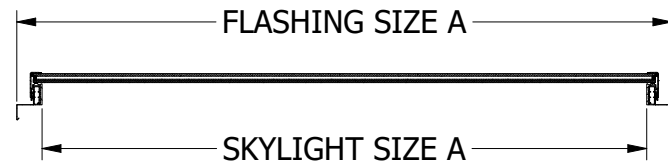

SECTION A-A  
SCALE 1 : 30

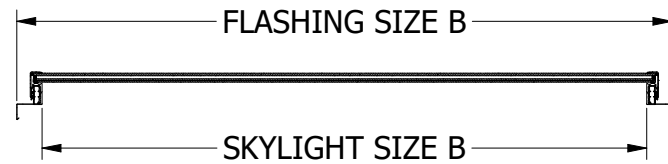

SECTION B-B  
SCALE 1 : 30

SKYLIGHT CODES AND SIZES

SINGLE GLAZED	DOUBLE GLAZED	SKYLIGHT SIZE A (mm)	SKYLIGHT SIZE B (mm)	FLASHING SIZE A (mm)	FLASHING SIZE B (mm)
GXL100150AU-SG	GXL100150AU-DG	1000	1500	1200	1700
GXL100200AU-SG	GXL100200AU-DG	1000	2000	1200	2200
GXL100250AU-SG	GXL100250AU-DG	1000	2500	1200	2700
GXL100300AU-SG	GXL100300AU-DG	1000	3000	1200	3200
GXL100350AU-SG	GXL100350AU-DG	1000	3500	1200	3700
GXL100400AU-SG	GXL100400AU-DG	1000	4000	1200	4200
GXL100450AU-SG	GXL100450AU-DG	1000	4500	1200	4700
GXL100500AU-SG	GXL100500AU-DG	1000	5000	1200	5200
GXL150150AU-SG	GXL150150AU-DG	1500	1500	1700	1700
GXL150200AU-SG	GXL150200AU-DG	1500	2000	1700	2200
GXL150250AU-SG	GXL150250AU-DG	1500	2500	1700	2700
GXL150300AU-SG	GXL150300AU-DG	1500	3000	1700	3200
GXL150350AU-SG	GXL150350AU-DG	1500	3500	1700	3700
GXL150400AU-SG	GXL150400AU-DG	1500	4000	1700	4200
GXL150450AU-SG	GXL150450AU-DG	1500	4500	1700	4700
GXL150500AU-SG	GXL150500AU-DG	1500	5000	1700	5200
GXL200200AU-SG	GXL200200AU-DG	2000	2000	2200	2200
GXL200250AU-SG	GXL200250AU-DG	2000	2500	2200	2700
GXL200300AU-SG	GXL200300AU-DG	2000	3000	2200	3200
GXL200350AU-SG	GXL200350AU-DG	2000	3500	2200	3700
GXL200400AU-SG	GXL200400AU-DG	2000	4000	2200	4200
GXL200450AU-SG	GXL200450AU-DG	2000	4500	2200	4700
GXL200500AU-SG	GXL200500AU-DG	2000	5000	2200	5200
GXL250250AU-SG	GXL250250AU-DG	2500	2500	2700	2700
GXL250300AU-SG	GXL250300AU-DG	2500	3000	2700	3200
GXL250350AU-SG	GXL250350AU-DG	2500	3500	2700	3700
GXL250400AU-SG	GXL250400AU-DG	2500	4000	2700	4200
GXL250450AU-SG	GXL250450AU-DG	2500	4500	2700	4700
GXL250500AU-SG	GXL250500AU-DG	2500	5000	2700	5200

CLIENT:	DESIGNER: J.BATOON	DATE CREATED: 12/07/2023	MATERIAL:	Skyspan Australia Pty Ltd 1 Gibbon Rd, Baulkham Hills NSW 2153, Australia Website: https://www.skyspan.com.au			REVISION
BUSINESS NAME:	DRAWN BY: M.AMIT	DATE DRAWN: 12/07/2023	THICKNESS (FOR SHEET):	PART NUMBER: SB-1991-00			A
PROJECT NAME:	MODIFIED BY:	DATE MODIFIED:	FINISH/COLOR:	TITLE: GXL - 0° TIMBER HOB		SHEET 7 OF 7	
QUOTE NUMBER:	CHECKED BY:	CHECKED DATE:	ESTIMATED MASS: N/A	VOLUME: N/A	FILENAME: SB-1991-00.iam		
WORK ORDER NUMBER:	APPROVED BY:	APPROVED DATE:			SCALE: DO NOT SCALE		
REFERENCE ORDER NUMBER:	TOLERANCES UNLESS OTHERWISE SPECIFIED IN MM				SHEET 7 OF 7		
JOB NUMBER:	FLASHING #:	COPYRIGHT: THE DESIGN DETAILS SHOWN ON THIS DRAWING ARE SPECIFIC TO THIS PROJECT ONLY AND MAY NOT BE REPRODUCED IN WHOLE OR IN PART OR BE USED FOR ANY OTHER PROJECT OR PURPOSE WITHOUT THE WRITTEN CONSENT OF EVENT ENGINEERING PTY LTD. ©COPYRIGHT 2023 SKYSPAN		SHEET 7 OF 7			
	FLASHING QTY:						