

FILL IN ALL BOXES PROVIDED.

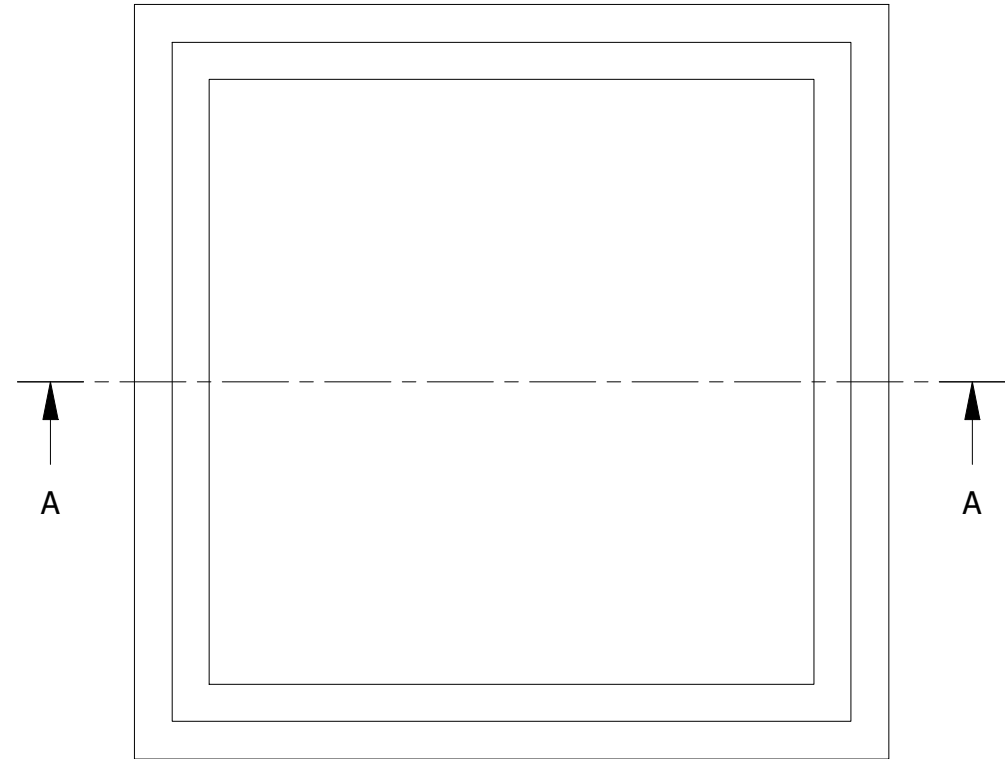

TOP VIEW
SCALE 1 : 30

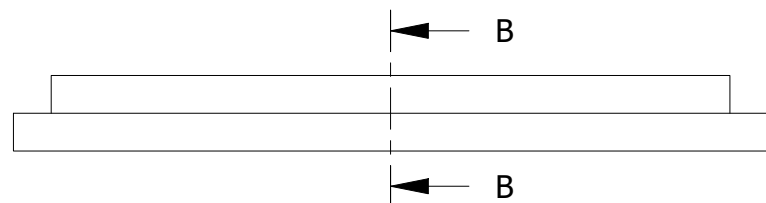

FRONT VIEW
SCALE 1 : 30

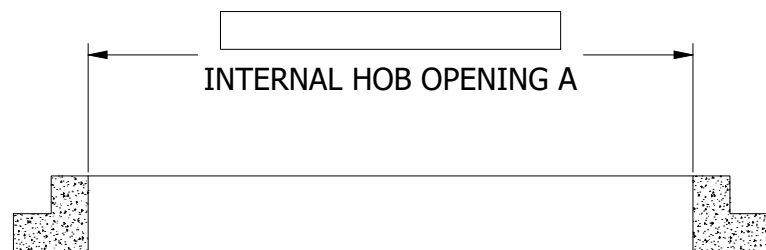

SECTION A-A
SCALE 1 : 30

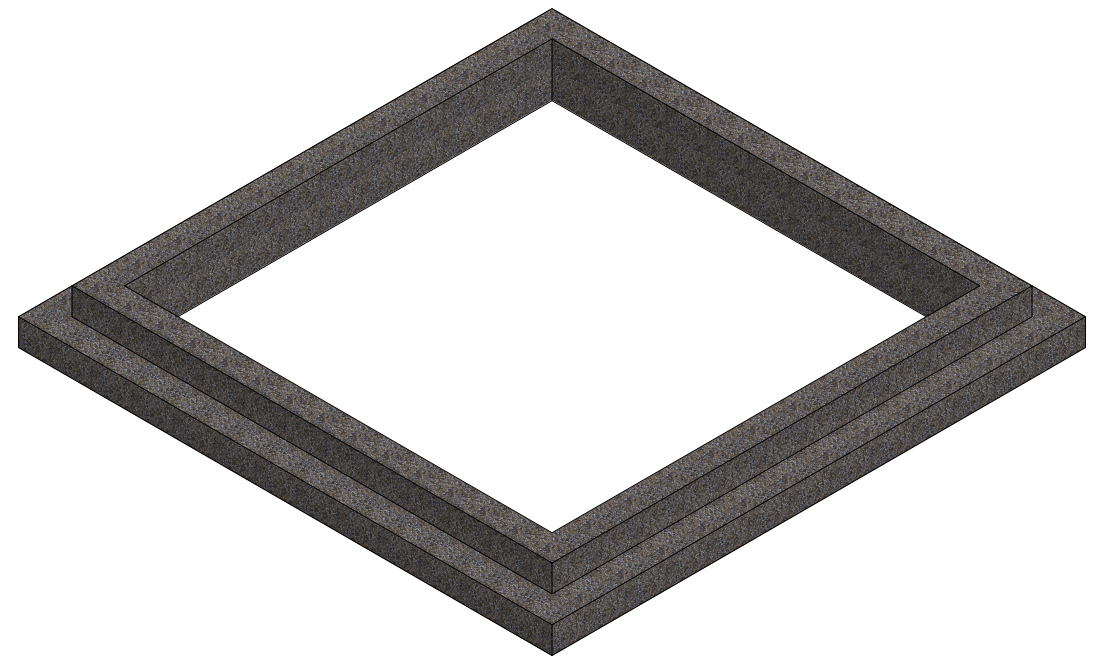

ISOMETRIC VIEW
SCALE 1 : 30

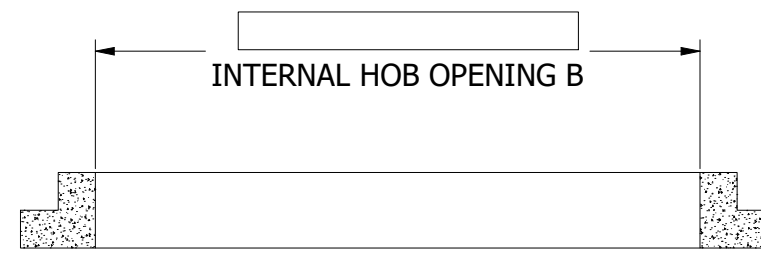

SECTION B-B
SCALE 1 : 30

Client Drawing Approval
Name:
Signature:
Date:

CLIENT:	DESIGNER: J.BATOON	DATE CREATED: 11-Jul-2023	MATERIAL:	Skyspan Australia Pty Ltd 1 Gibbon Rd, Baulkham Hills NSW 2153, Australia Website:https://www.skyspan.com.au	
BUSINESS NAME:	DRAWN BY: C.QUINOL	DATE DRAWN: 04-Mar-2024	THICKNESS (FOR SHEET):		
PROJECT NAME:	MODIFIED BY:	DATE MODIFIED:	FINISH/COLOR:	PART NUMBER: SB-2060-00	REVISION A
QUOTE NUMBER:	CHECKED BY:	CHECKED DATE:	ESTIMATED MASS: N/A	VOLUME: N/A	GXL - 0° CONCRETE HOB
WORK ORDER NUMBER:	APPROVED BY:	APPROVED DATE:	SIZE A3	SCALE: DO NOT SCALE	
REFERENCE ORDER NUMBER:	TOLERANCES UNLESS OTHERWISE SPECIFIED IN MM			THIRD ANGLE PROJECTION	FILENAME: SB-2060-00.iam
JOB NUMBER:	FLASHING #:	COPYRIGHT: THE DESIGN DETAILS SHOWN ON THIS DRAWING ARE SPECIFIC TO THIS PROJECT ONLY AND MAY NOT BE REPRODUCED IN WHOLE OR IN PART OR BE USED FOR ANY OTHER PROJECT OR PURPOSE WITHOUT THE WRITTEN CONSENT OF EVENT ENGINEERING PTY LTD. ©COPYRIGHT 2023 SKYSPAN			SHEET 1 OF 6
	FLASHING QTY:				

This Skylight system is covered by Australian Patent Pending Number 2021901063 and New Zealand Patent Pending Number 774968.

FILL IN ALL BOXES PROVIDED.

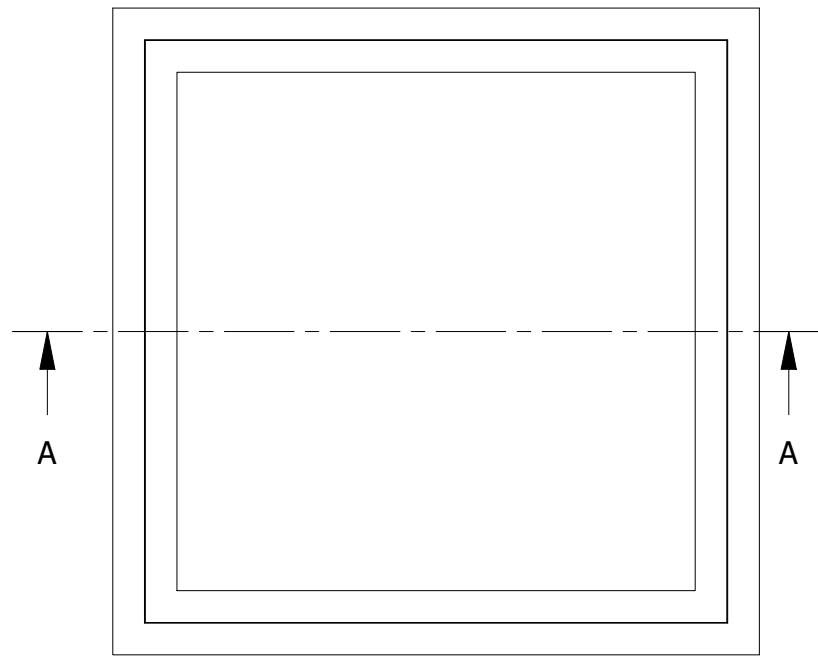

TOP VIEW
SCALE 1 : 35

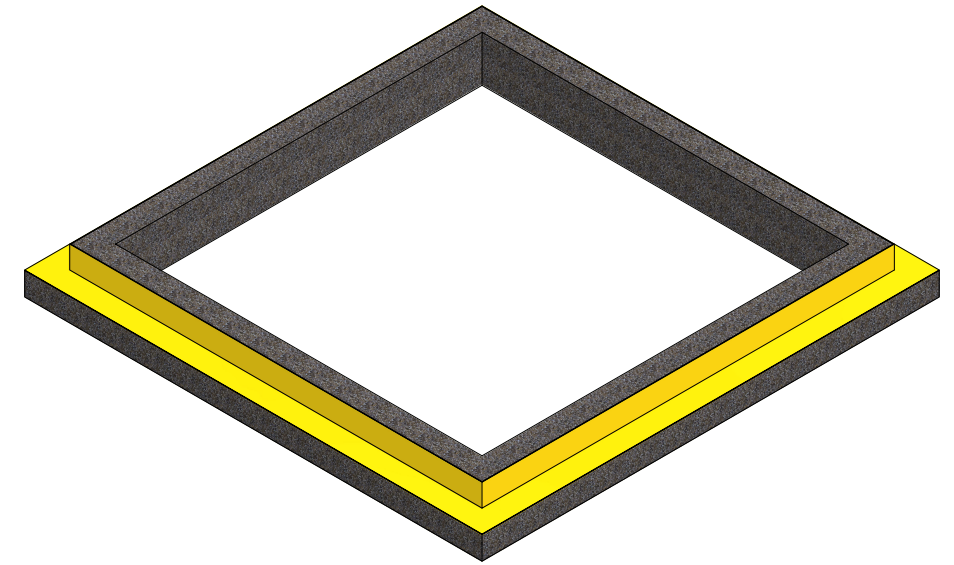

ISOMETRIC VIEW
SCALE 1 : 35

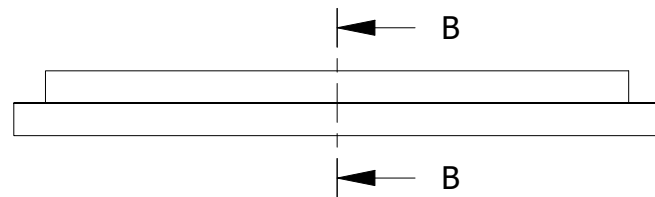

FRONT VIEW
SCALE 1 : 35

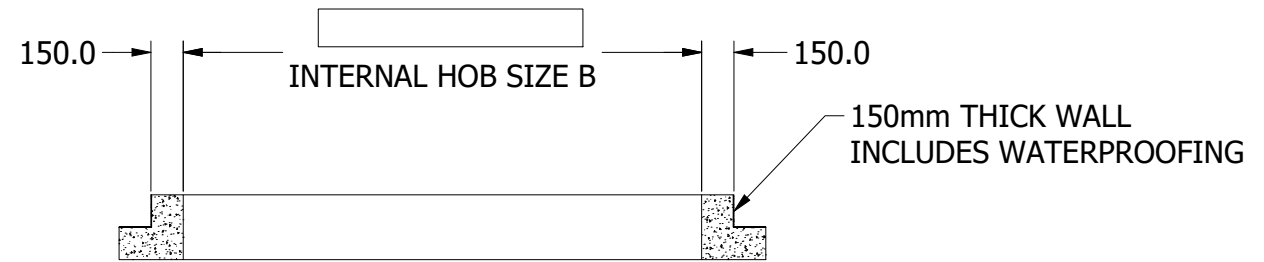

SECTION B-B
SCALE 1 : 35

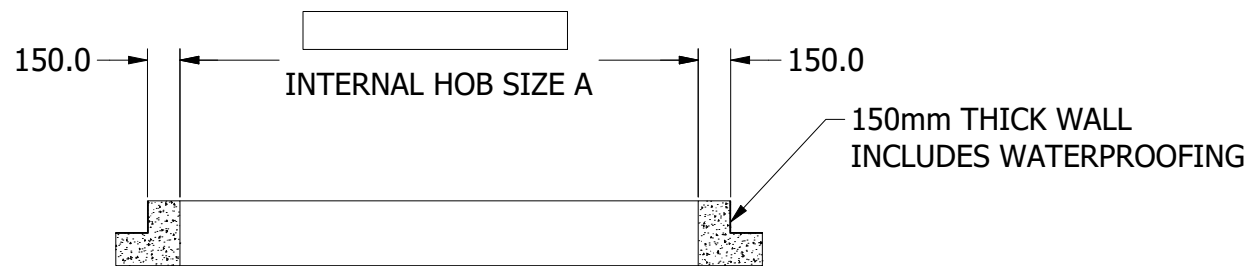

SECTION A-A
SCALE 1 : 35

Client Drawing Approval
Name:
Signature:
Date:

CLIENT:	DESIGNER: J.BATOON	DATE CREATED: 11-Jul-2023	MATERIAL:	Skyspan Australia Pty Ltd 1 Gibbon Rd, Baulkham Hills NSW 2153, Australia Website: https://www.skyspan.com.au	
BUSINESS NAME:	DRAWN BY: C.QUINOL	DATE DRAWN: 04-Mar-2024	THICKNESS (FOR SHEET):		
PROJECT NAME:	MODIFIED BY:	DATE MODIFIED:	FINISH/COLOR:	PART NUMBER: SB-2060-00	REVISION A
QUOTE NUMBER:	CHECKED BY:	CHECKED DATE:	ESTIMATED MASS: N/A	VOLUME: N/A	
WORK ORDER NUMBER:	APPROVED BY:	APPROVED DATE:	SCALE: DO NOT SCALE	FILENAME: SB-2060-00.iam	SHEET 2 OF 6
REFERENCE ORDER NUMBER:	<small>TOLERANCES UNLESS OTHERWISE SPECIFIED IN MM</small> <small>COPYRIGHT: THE DESIGN DETAILS SHOWN ON THIS DRAWING ARE SPECIFIC TO THIS PROJECT ONLY AND MAY NOT BE REPRODUCED IN WHOLE OR IN PART OR BE USED FOR ANY OTHER PROJECT OR PURPOSE WITHOUT THE WRITTEN CONSENT OF EVENT ENGINEERING PTY LTD. ©COPYRIGHT 2023 SKYSPAN</small>				SIZE A3
JOB NUMBER:	FLASHING #:	FLASHING QTY:			

This Skylight system is covered by Australian Patent Pending Number 2021901063 and New Zealand Patent Pending Number 774968.

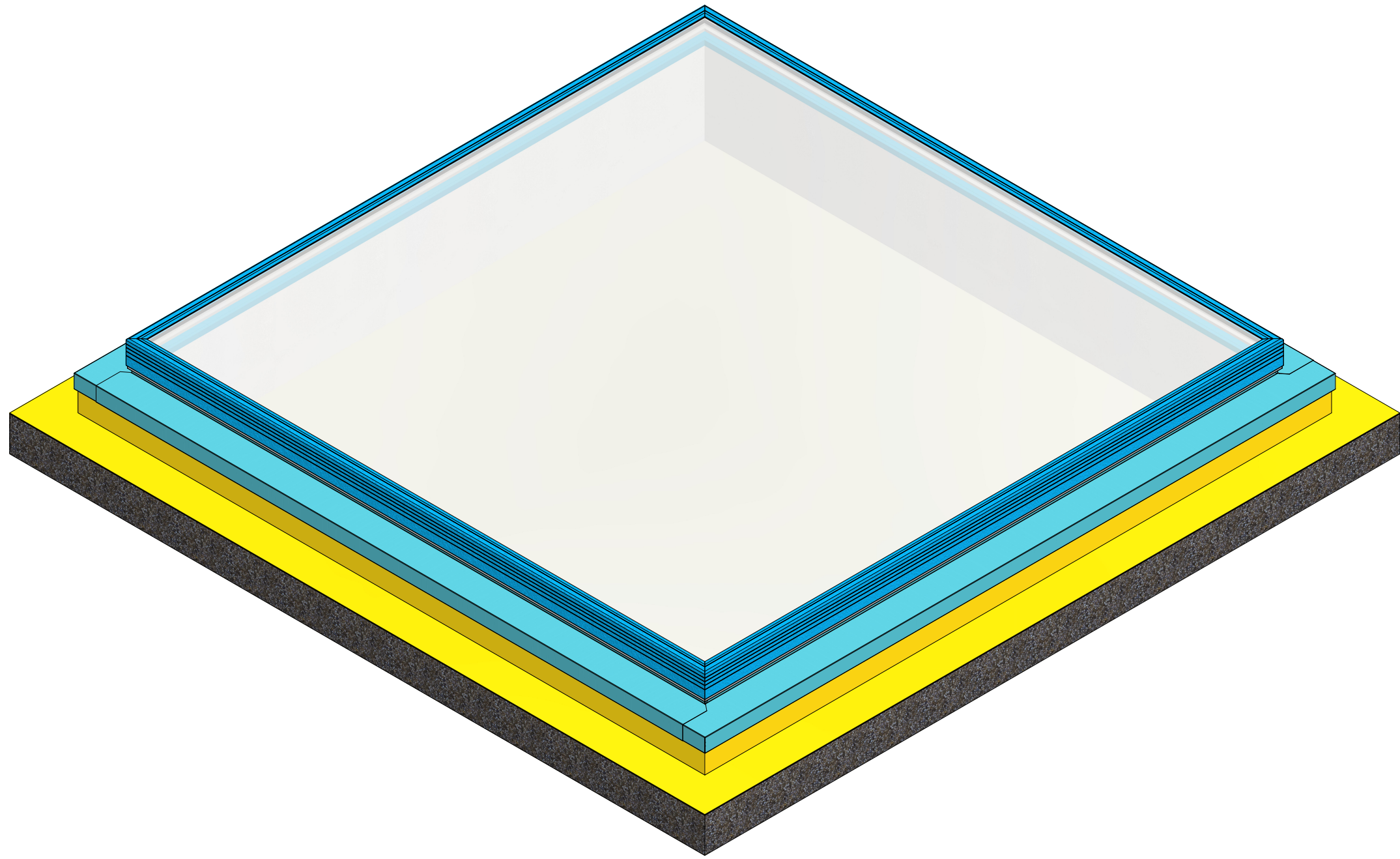

ISOMETRIC VIEW
SCALE 1 : 15

Note: Waterproofing example shown as yellow is by others.

This Skylight system is covered by Australian Patent Pending Number 2021901063 and New Zealand Patent Pending Number 774968.

CLIENT:	DESIGNER: J.BATOON	DATE CREATED: 11-Jul-2023	MATERIAL:	Skyspan Australia Pty Ltd		
BUSINESS NAME:	DRAWN BY: C.QUINOL	DATE DRAWN: 04-Mar-2024	THICKNESS (FOR SHEET):	1 Gibbon Rd, Baulkham Hills NSW 2153, Australia Website: https://www.skyspan.com.au		
PROJECT NAME:	MODIFIED BY:	DATE MODIFIED:	FINISH/COLOR:	PART NUMBER: SB-2060-00	REVISION A	
QUOTE NUMBER:	CHECKED BY:	CHECKED DATE:	ESTIMATED MASS: N/A	VOLUME: N/A	TITLE: GXL - 0° CONCRETE HOB	
WORK ORDER NUMBER:	APPROVED BY:	APPROVED DATE:	SIZE A3		SCALE: DO NOT SCALE	
REFERENCE ORDER NUMBER:	TOLERANCES UNLESS OTHERWISE SPECIFIED IN MM		THIRD ANGLE PROJECTION		FILENAME: SB-2060-00.iam	SHEET 3 OF 6
JOB NUMBER:	FLASHING #:	COPYRIGHT: THE DESIGN DETAILS SHOWN ON THIS DRAWING ARE SPECIFIC TO THIS PROJECT ONLY AND MAY NOT BE REPRODUCED IN WHOLE OR IN PART OR BE USED FOR ANY OTHER PROJECT OR PURPOSE WITHOUT THE WRITTEN CONSENT OF EVENT ENGINEERING PTY LTD. ©COPYRIGHT 2023 SKYSPAN				
	FLASHING QTY:					

FILL IN ALL BOXES PROVIDED.

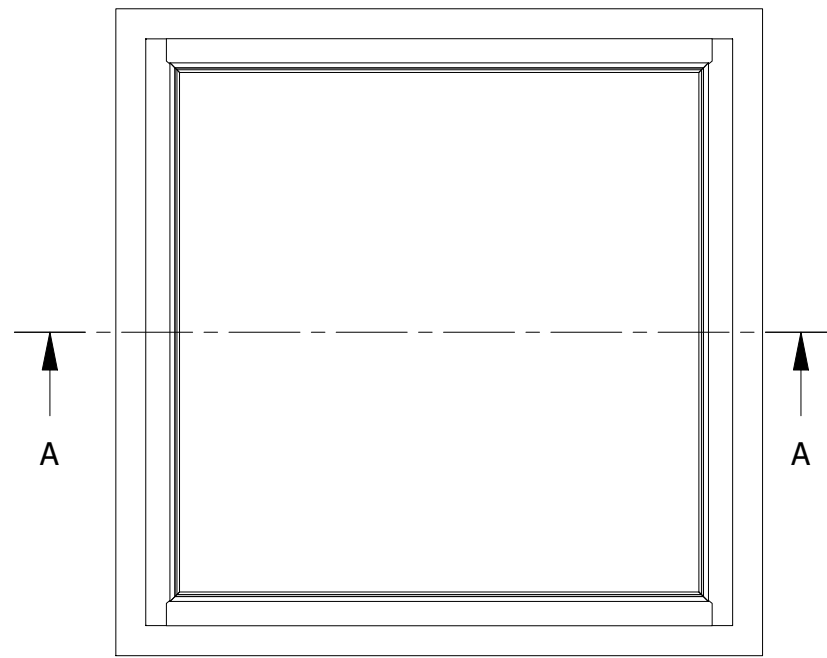

TOP VIEW
SCALE 1 : 35

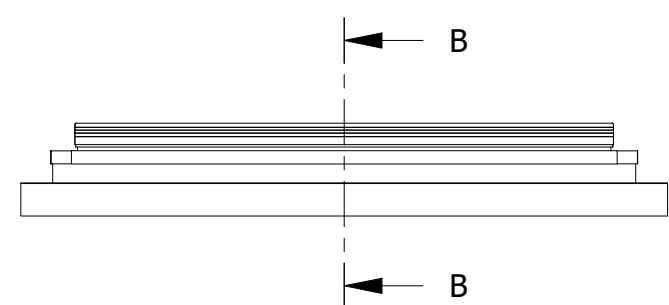

FRONT VIEW
SCALE 1 : 35

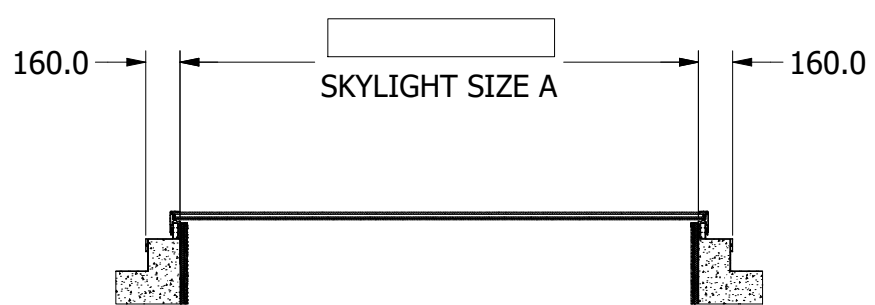

SECTION A-A
SCALE 1 : 35

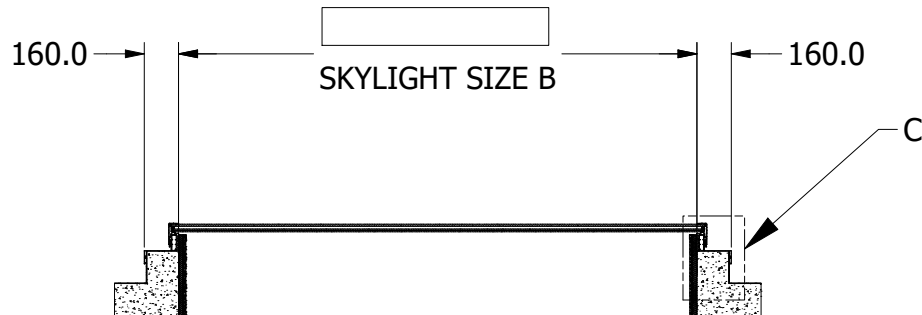

SECTION B-B
SCALE 1 : 35

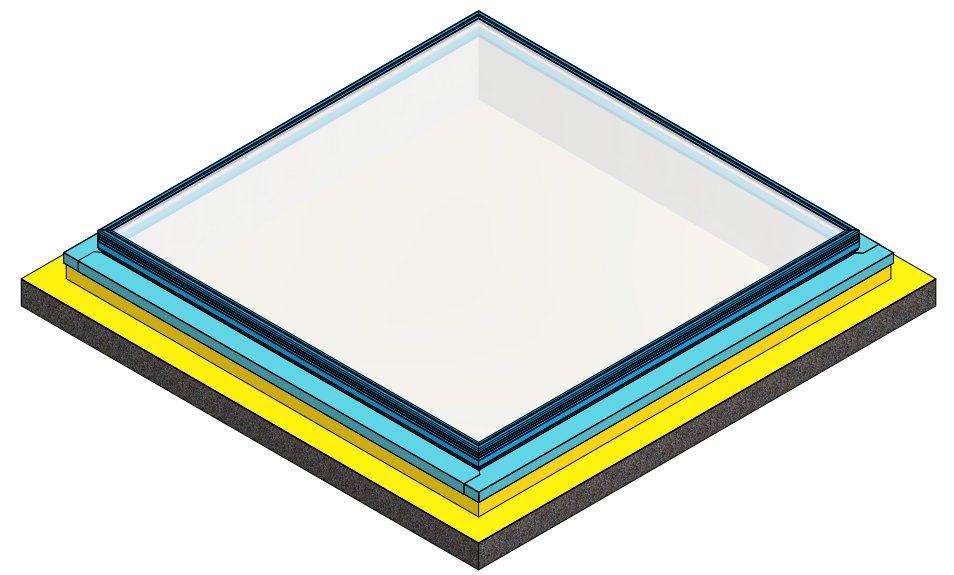

ISOMETRIC VIEW
SCALE 1 : 35

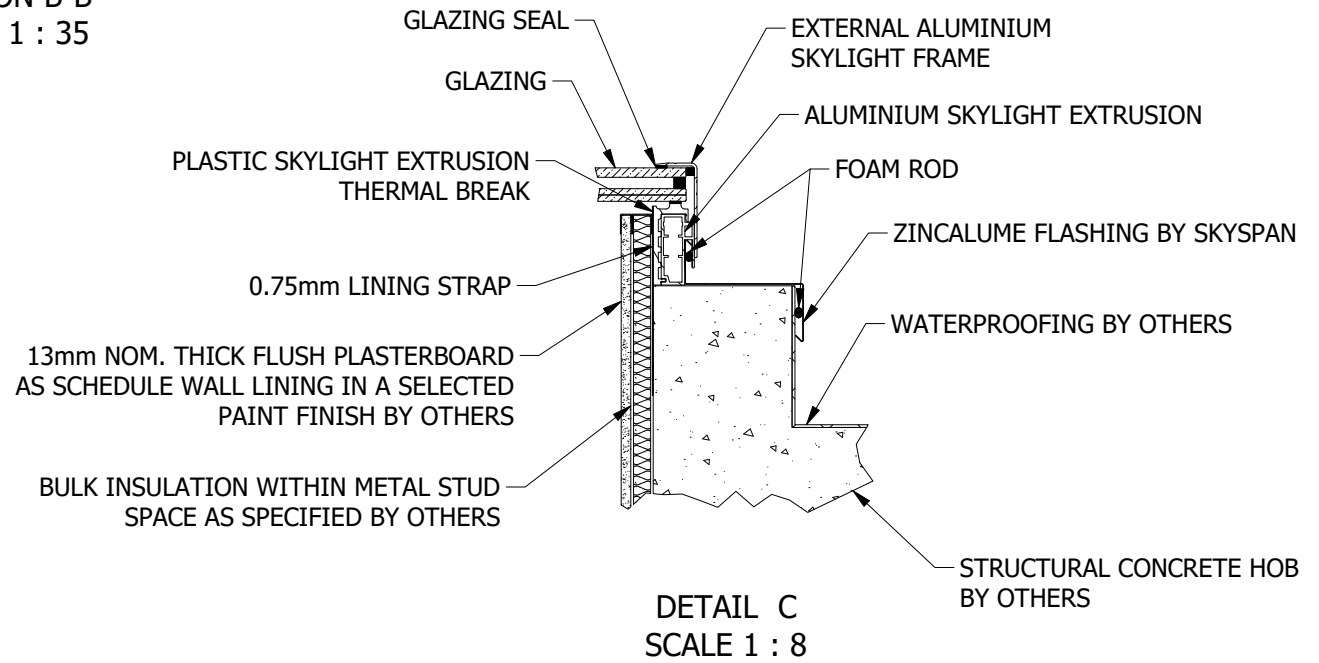

DETAIL C
SCALE 1 : 8

NOTE:
SKYSPAN RECOMMENDS MINIMUM OF 10MM ADDITIONAL CLEARANCE FOR FLASHING TO ALL SIDES TO ALLOW FOR HOB DISCREPANCIES. EACH HOB IS CONSTRUCTED DIFFERENT SO FLASHING CLEARANCE MUST BE SET BY THE CUSTOMER.

This Skylight system is covered by Australian Patent Pending Number 2021901063 and New Zealand Patent Pending Number 774968.

Client Drawing Approval
Name: _____
Signature: _____
Date: _____

CLIENT:	DESIGNER: J.BATOON	DATE CREATED: 11-Jul-2023	MATERIAL:	Skyspan Australia Pty Ltd 1 Gibbon Rd, Baulkham Hills NSW 2153, Australia Website: https://www.skyspan.com.au	
BUSINESS NAME:	DRAWN BY: C.QUINOL	DATE DRAWN: 04-Mar-2024	THICKNESS (FOR SHEET):		
PROJECT NAME:	MODIFIED BY:	DATE MODIFIED:	FINISH/COLOR:	PART NUMBER: SB-2060-00	REVISION: A
QUOTE NUMBER:	CHECKED BY:	CHECKED DATE:	ESTIMATED MASS: N/A	VOLUME: N/A	GXL - 0° CONCRETE HOB
WORK ORDER NUMBER:	APPROVED BY:	APPROVED DATE:	SCALE: DO NOT SCALE	FILENAME: SB-2060-00.iam	
REFERENCE ORDER NUMBER:	TOLERANCES UNLESS OTHERWISE SPECIFIED IN MM			SIZE: A3	SHEET 4 OF 6
JOB NUMBER:	FLASHING #:	COPYRIGHT: THE DESIGN DETAILS SHOWN ON THIS DRAWING ARE SPECIFIC TO THIS PROJECT ONLY AND MAY NOT BE REPRODUCED IN WHOLE OR IN PART OR BE USED FOR ANY OTHER PROJECT OR PURPOSE WITHOUT THE WRITTEN CONSENT OF EVENT ENGINEERING PTY LTD. ©COPYRIGHT 2023 SKYSPAN			
FLASHING QTY:					

FILL IN ALL BOXES PROVIDED.

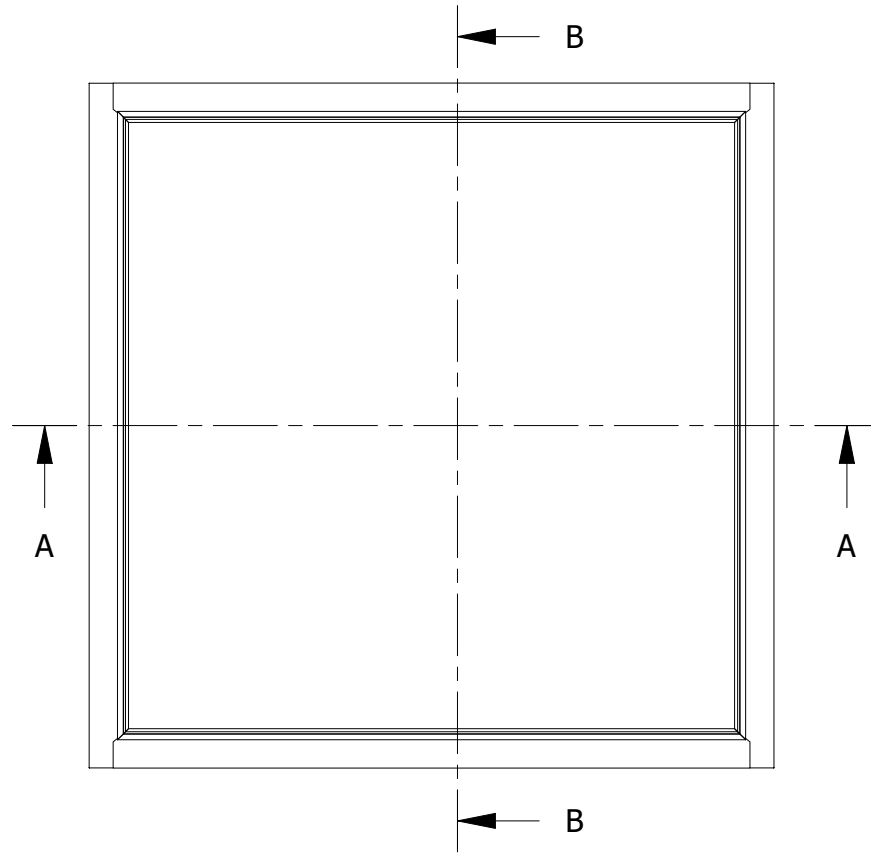

TOP VIEW
SCALE 1 : 30

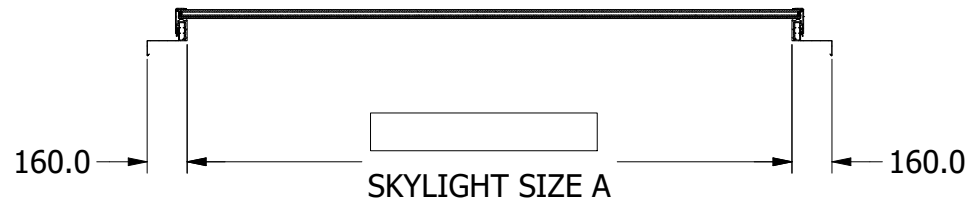

SECTION A-A
SCALE 1 : 30

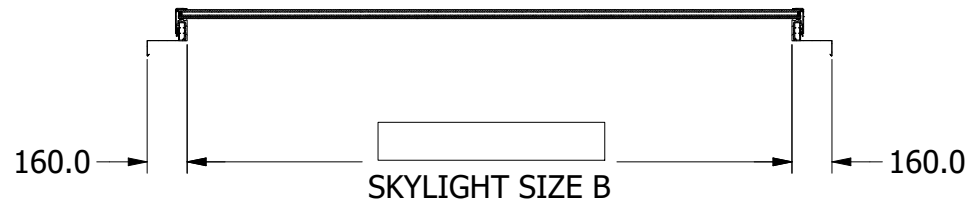

SECTION B-B
SCALE 1 : 30

Client Drawing Approval
Name:
Signature:
Date:

CLIENT:	DESIGNER: J.BATOON	DATE CREATED: 11-Jul-2023	MATERIAL:	Skyspan Australia Pty Ltd 1 Gibbon Rd, Baulkham Hills NSW 2153, Australia Website: https://www.skyspan.com.au	
BUSINESS NAME:	DRAWN BY: C.QUINOL	DATE DRAWN: 04-Mar-2024	THICKNESS (FOR SHEET):		
PROJECT NAME:	MODIFIED BY:	DATE MODIFIED:	FINISH/COLOR:	PART NUMBER: SB-2060-00	REVISION: A
QUOTE NUMBER:	CHECKED BY:	CHECKED DATE:	ESTIMATED MASS: N/A	VOLUME: N/A	
WORK ORDER NUMBER:	APPROVED BY:	APPROVED DATE:	SCALE: DO NOT SCALE	SIZE: A3	TITLE: GX - 0° CONCRETE HOB
REFERENCE ORDER NUMBER:	TOLERANCES UNLESS OTHERWISE SPECIFIED IN MM			THIRD ANGLE PROJECTION	FILENAME: SB-2060-00.iam
JOB NUMBER:	FLASHING #:	COPYRIGHT: THE DESIGN DETAILS SHOWN ON THIS DRAWING ARE SPECIFIC TO THIS PROJECT ONLY AND MAY NOT BE REPRODUCED IN WHOLE OR IN PART OR BE USED FOR ANY OTHER PROJECT OR PURPOSE WITHOUT THE WRITTEN CONSENT OF EVENT ENGINEERING PTY LTD. ©COPYRIGHT 2023 SKYSPAN			SHEET 5 OF 6
	FLASHING QTY:				

This Skylight system is covered by Australian Patent Pending Number 2021901063 and New Zealand Patent Pending Number 774968.

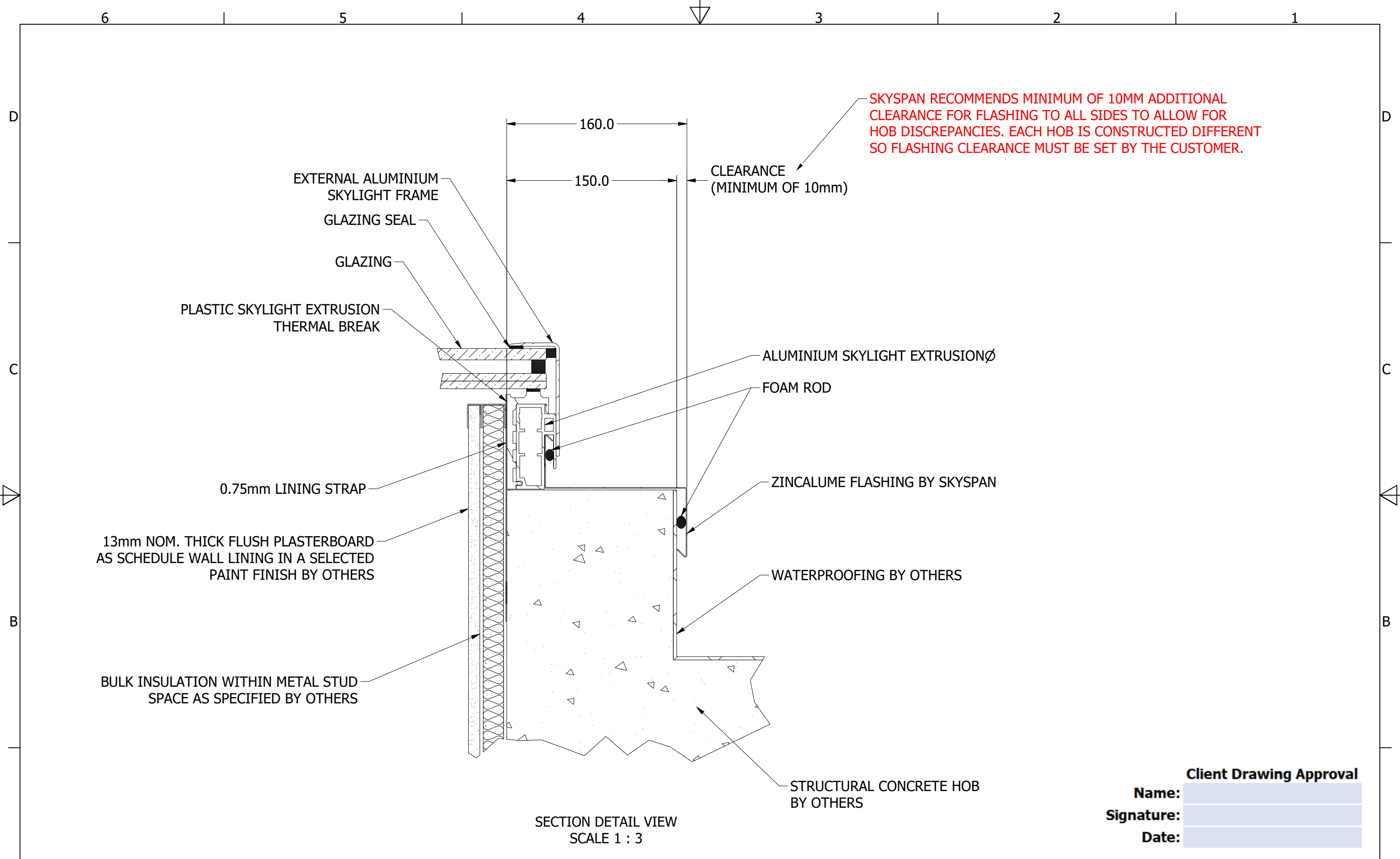

SECTION DETAIL VIEW
SCALE 1 : 3

Client Drawing Approval
 Name:
 Signature:
 Date:

CLIENT:	DESIGNER: J.BATOON	DATE CREATED: 11-Jul-2023	MATERIAL:	Skyspan Australia Pty Ltd 1 Gibbon Rd, Baulkham Hills NSW 2153, Australia Website: https://www.skyspan.com.au	
BUSINESS NAME:	DRAWN BY: C.QUINOL	DATE DRAWN: 04-Mar-2024	THICKNESS (FOR SHEET):		
PROJECT NAME:	MODIFIED BY:	DATE MODIFIED:	FINISH/COLOR:	PART NUMBER: SB-2060-00	REVISION A
QUOTE NUMBER:	CHECKED BY:	CHECKED DATE:	ESTIMATED MASS: N/A	VOLUME: N/A	
WORK ORDER NUMBER:	APPROVED BY:	APPROVED DATE:	SIZE A3	TITLE: GXL - 0° CONCRETE HOB	
REFERENCE ORDER NUMBER:	TOLERANCES UNLESS OTHERWISE SPECIFIED IN MM			SCALE: DO NOT SCALE	FILENAME: SB-2060-00.iam
JOB NUMBER:	FLASHING #:	COPYRIGHT: THE DESIGN DETAILS SHOWN ON THIS DRAWING ARE SPECIFIC TO THIS PROJECT ONLY AND MAY NOT BE REPRODUCED IN WHOLE OR IN PART OR BE USED FOR ANY OTHER PROJECT OR PURPOSE WITHOUT THE WRITTEN CONSENT OF EVENT ENGINEERING PTY LTD. ©COPYRIGHT 2023 SKYSPAN			SHEET 6 OF 6
	FLASHING QTY:				

This Skylight system is covered by Australian Patent Pending Number 2021901063 and New Zealand Patent Pending Number 774968.